

**Shaper Cutters**  
While Supplies Last!

# GABINET DOOR RAISED PANEL CUTTERS **WEAVER** Stehle

**5/8" Raised Panel Cutters for Single Raise** . . . for 5/8" stock, face up. Use 2-1/4" O.D. Ball Bearing Rub Collar - If you need a ball bearing rub collar, order item #BB2086 - Price \$39 (not included in cutter price)

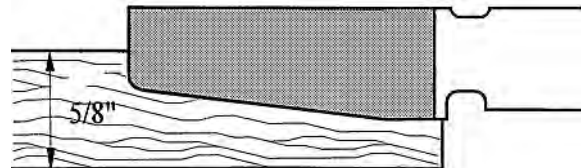
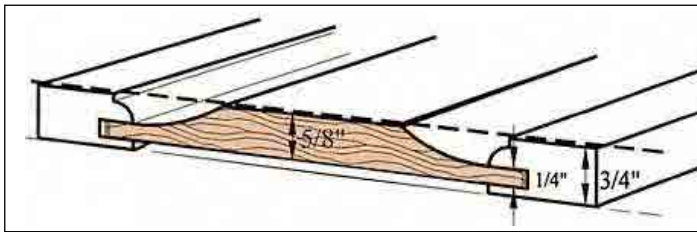

Item#	Wings	OD	Bore	Type	Price
<b>C7099D3</b>	2	5 1/2"	1 1/4"	Carbide	<b>\$199</b>

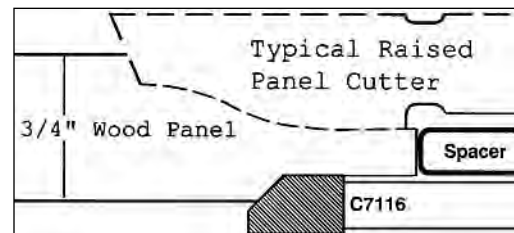

Item#	Wings	O.D.	Bore	Type	Price
<b>C7116</b>	3	4"	1 1/4"	Carbide	<b>\$86</b>

## 5/8" Raised Panel Cutters for Single Raise - Stock Face Down



Item#	Wings	Type	Price
<b>C7158D1</b>	2	HSS	<b>\$129</b>
<b>C7159D1</b>	2	Carbide	<b>\$186</b>

*"Not Recessed for Bearing"*

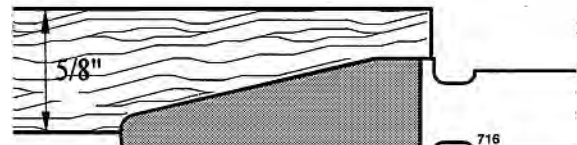

Item#	Wings	Type	Price
<b>C7169</b>	2	Carbide	<b>\$186</b>

*"Recessed for Bearing"*



Item#	Wings	Type	Price
<b>C7148D1</b>	2	HSS	<b>\$129</b>

*"Not Recessed for Bearing"*

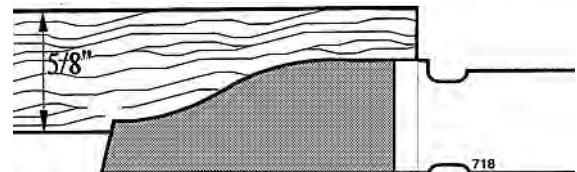

Item#	Wings	Type	Price
<b>C7188D1</b>	2	HSS	<b>\$129</b>

*"Not Recessed for Bearing"*

MADE IN GERMANY

(These Raised Panel Cutters are 5 1/2" Diameter, 1 1/4" Bore)

Phone 1-913-831-1800

**CALL TOLL FREE 1-800-255-6214**

Fax 1-913-831-2974

CAT-SUP-CU-WSL - 120 -

WEAVER COMPANY - 1108 SOUTH 37TH STREET - KANSAS CITY, KS 66106 USA

Copyright © 2014 all Rights Reserved

# RAISED PANEL CUTTERS

For 3/4" stock

**Shaper Cutters**  
*While Supplies Last!*

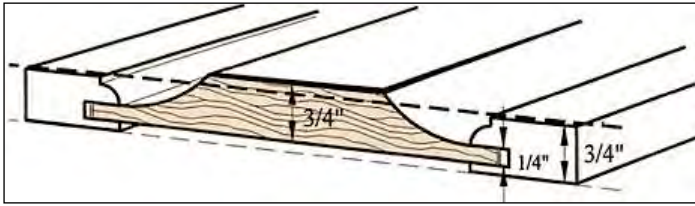

For 3/4" stock, face up. Use 2 1/4" O.D. Ball Bearing Rub Collar - If you need a ball bearing rub collar, order item #BB2086 - Price \$39 (not included in cutter price)



Item#	Wings	Type	Price
<b>C7018F3</b>	2	High Speed Steel	<b>\$139</b>



Item#	Wings	Type	Price
<b>C7038F3</b>	2	High Speed Steel	<b>\$139</b>
<b>C7039F3</b>	2	Carbide	<b>\$199</b>

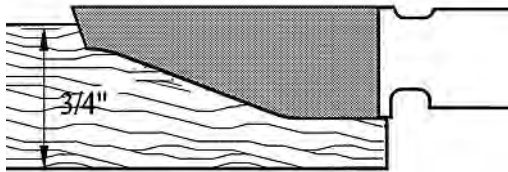

Item#	Wings	Type	Price
<b>C7078F3HD</b>	2	High Speed Steel	<b>\$139</b>

(These Raised Panel Cutters are 5 1/2" Diameter, 1 1/4" Bore)

## 3/4" Raised Panel Cutters for Single Raise - Stock Face Down

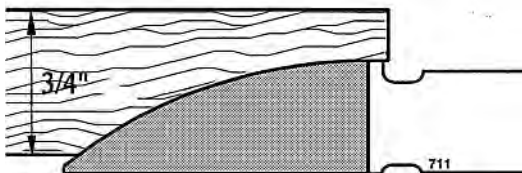

Item#	Wings	Type	Price
<b>C7119F1</b>	2	Carbide	<b>\$199</b>

*"Not Recessed for Bearing"*

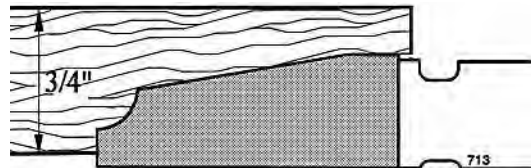

Item#	Wings	Type	Price
<b>C7138F1</b>	2	HSS	<b>\$139</b>
<b>C7139F1</b>	2	Carbide	<b>\$199</b>

*"No Shear"*  
*"Not Recessed for Bearing"*

(These Raised Panel Cutters are 5 1/2" Diameter, 1 1/4" Bore)

**MADE IN GERMANY**

**Shaper Cutters**  
While Supplies Last!

# SQUARE EDGE CUTTERS

1 1/4 Bore



ALL SQUARE EDGE CUTTERS WILL GROOVE AND RABBET

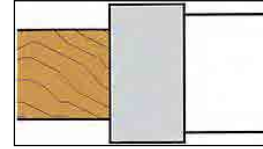
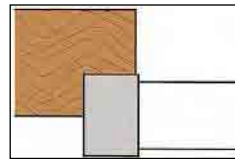
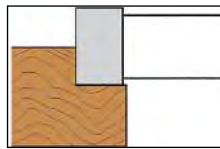
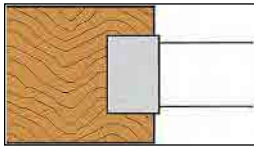

**7/32" Wide Carbide Cutters**

Item#	Wings	O.D.	Width	Price
C90X9-A3-7/32	2	4"	7/32"	\$69

**7/32" Wide High Speed Steel Cutters**

Item#	Wings	O.D.	Width	Price
C90X8-A3-7/32	2	4"	7/32"	\$55



**1/4" Wide Carbide Cutters**

Item#	Wings	O.D.	Width	Price
C8306V	3	3 1/2"	1/4"	\$79
C9019-B2	2	4"	1/4"	\$69

**1/4" Wide High Speed Steel Cutters**

Item#	Wings	O.D.	Width	Price
C8308V	2	3 1/2"	1/4"	\$55
STE.250x3.937-8	2	3 15/16"	1/4"	\$55
C9038-A3	2	4"	1/4"	\$55

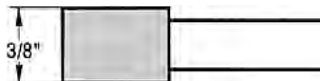

**3/8" Wide High Speed Steel Cutters**

Item#	Wings	O.D.	Width	Price
C8318V	2	3 1/2"	3/8	\$60

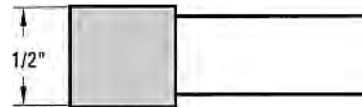

**1/2" Wide High Speed Steel Cutters**

Item#	Wings	O.D.	Width	Price
C9278V	2	3"	1/2"	\$69
C9268V	2	4"	1/2"	\$69

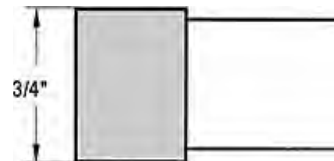

**3/4" Wide Carbide Cutters**

Item#	Wings	O.D.	Width	Price
C9249V	2	3 1/8"	3/4"	\$99
C8339V	2	3 1/2"	3/4"	\$99
C9259V	2	3 7/8"	3/4"	\$99

**3/4" Wide High Speed Steel Cutters**

Item#	Wings	O.D.	Width	Price
C9288V	2	3"	3/4"	\$79
C9248V	2	3 1/8"	3/4"	\$79
C9238V	2	4"	3/4"	\$79

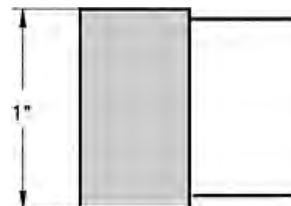

**1" Wide High Speed Steel Cutters**

Item#	Wings	O.D.	Width	Price
C8348V	2	3 1/2"	1"	\$89

MADE IN GERMANY

Phone 1-913-831-1800

**CALL TOLL FREE 1-800-255-6214**

Fax 1-913-831-2974

CAT-SUP-CU-WSL - 122 -

WEAVER COMPANY - 1108 SOUTH 37TH STREET - KANSAS CITY, KS 66106 USA

Copyright © 2014 all Rights Reserved

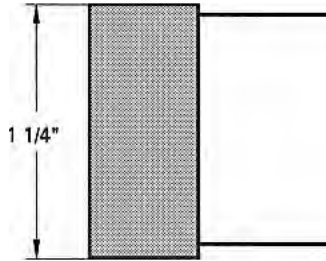

**1-1/4" Wide High Speed Steel Cutters**

Item#	Wings	O.D.	Width	Price
C8358V	2	3-1/2"	1-1/4"	\$99

**30° Cutters:**

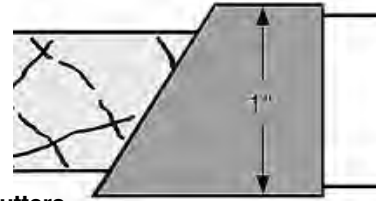

**30 Degree Cutters**

Item#	Wings	Type	O.D.	Price
C8226V	3	Carbide	3 <sup>29</sup> / <sub>32</sub>	\$109
C8228V	2	HighSpeed Steel	3 <sup>29</sup> / <sub>32</sub>	\$79

**45° Cutters:**

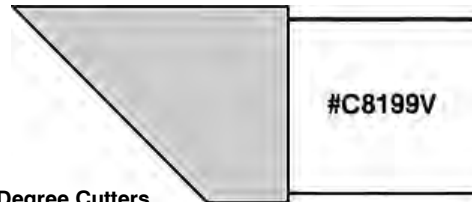

**45 Degree Cutters**

Item#	Wings	Type	O.D.	Price
C8196V	3	Carbide	4 <sup>3</sup> / <sub>4</sub>	\$109
C8199V	2	Carbide	4 <sup>3</sup> / <sub>4</sub>	\$99

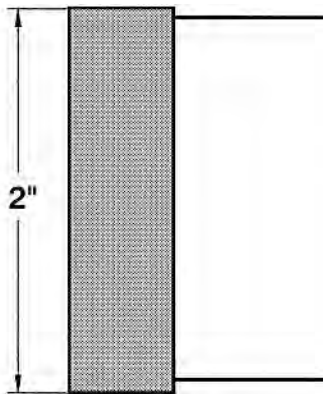

**2" Wide Carbide Cutters**

Item#	Wings	O.D.	Width	Price
C8366V	3	3-1/2"	2"	\$179

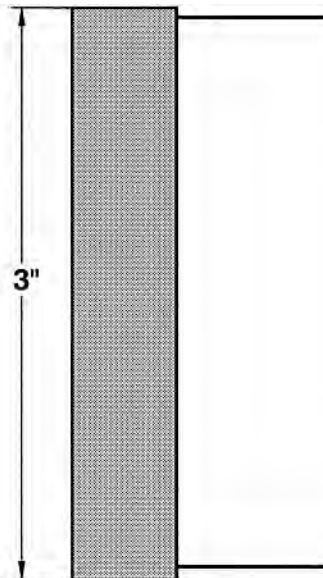

**3" Wide Carbide Cutters**

Item#	Wings	O.D.	Width	Price
C8379V	2	3-1/2"	3"	\$229

MADE IN GERMANY

www.weaver-company.com

Phone 1-913-831-1800

**CALL TOLL FREE 1-800-255-6214**

Fax 1-913-831-2974

Copyright © 2014 all Rights Reserved

WEAVER COMPANY - 1108 SOUTH 37TH STREET - KANSAS CITY, KS 66106 USA

CAT-SUP-CU-WSL - 123 -

## DRAWER FRONT RAISERS

### Drawer Front Raisers

This cutter will work on any thickness of material. The design of the cutter will match beautifully with many door styles. As a special feature, this cutter bevels the outside edge of the drawer front, eliminating a step on the edge sander.



(6" Diameter)

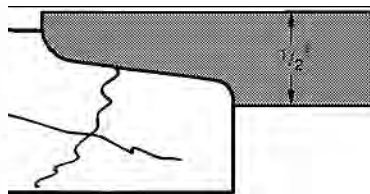

Stock Face Up

#### Drawer Raising Cutters - 3/4" Bore

Item#	Wings	O.D.	Type	Price
<b>C8087V3</b>	2	6"	High Speed Steel	<b>\$149</b>



(5 1/2" Diameter)

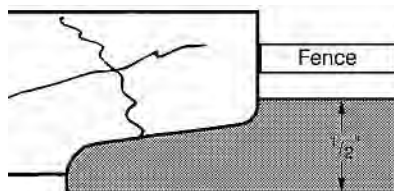

Stock Face Down

#### Drawer Raising Cutters - 1 1/4" Bore

Item#	Wings	O.D.	Type	Price
<b>C8088V1</b>	2	5-1/2"	High Speed Steel	<b>\$149</b>

## DRAWER LOCK CUTTERS

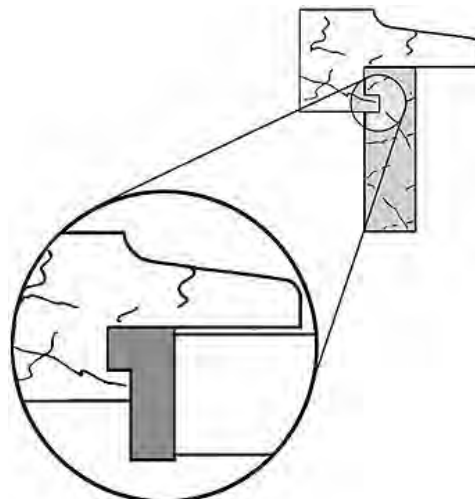

### Drawer Lock Cutter

Item No.	O.D.	I.D.	Wings	Height	Type	Price
<b>C8136V</b>	5-1/4"	1 1/4"	3	3/4"	Carbide	<b>\$175</b>

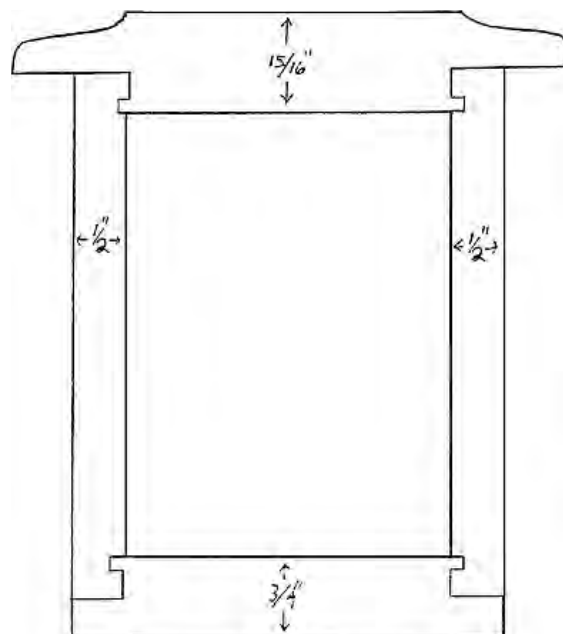

MADE IN GERMANY

Phone 1-913-831-1800

**CALL TOLL FREE 1-800-255-6214**

Fax 1-913-831-2974

CAT-SUP-CU-WSL - 124 -

WEAVER COMPANY - 1108 SOUTH 37TH STREET - KANSAS CITY, KS 66106 USA

Copyright © 2014 all Rights Reserved

**DETAIL EDGE CUTTERS**

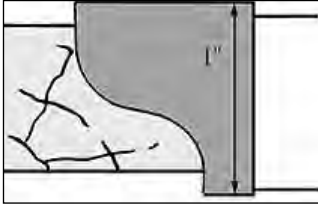

**Detail Edge Cutters**

Item#	Wings	O.D.	Type	Price
<b>C8266V</b>	3	4"	Carbide	<b>\$219</b>

**DOOR LIP CUTTERS**

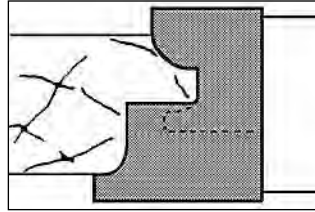

**Door Lip Cutters**

Item#	Wings	O.D.	Type	Price
<b>C8928V</b>	3	3 61/64"	HSS	<b>\$119</b>

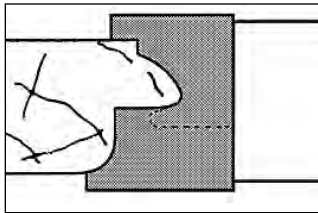

**Door Lip Cutters**

Item#	Wings	O.D.	Type	Price
<b>C8908V</b>	2	3 61/64"	HSS	<b>\$119</b>

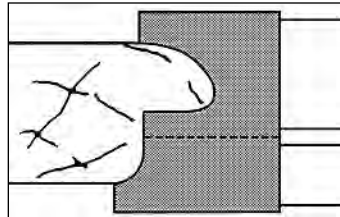

**Door Lip Cutters**

Item#	Wings	O.D.	Type	Price
<b>C8938V</b>	3	3 61/64"	HSS	<b>\$119</b>
<b>C8936V</b>	3	3 61/64"	Carbide	<b>\$199</b>

**REVERSING CUTTERS**



Reversing Cutters shape both the ends and the edge of the material being used. To use, shape both ends of the rail and then turn the board over and run the shape on the edge. These cutters are excellent for making English library paneling over 3/4" plywood on wall or flat panel cabinet doors.

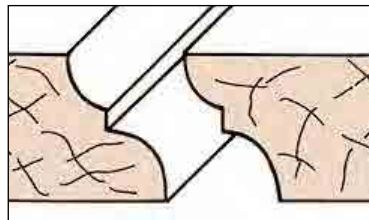

**Reversing Profile Edge Cutters**

Item#	Wings	O.D.	Type	Price
<b>C8016V</b>	3	3 3/4"	Carbide	<b>\$249</b>

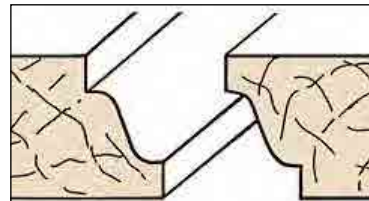
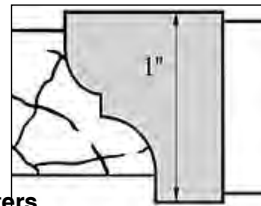

**Reversing Profile Edge Cutters**

Item#	Wings	O.D.	Type	Price
<b>C8026V</b>	3	3-3/4"	Carbide	<b>\$249</b>



MADE IN GERMANY

www.weaver-company.com

**Shaper Cutters**  
*While Supplies Last!*

# V-PANELING CUTTERS

1 1/4 Bore



Both sides "V"



Item No.	Description	Price
C-8169-V	2 Wing Carbide	\$529
C-8166-V	3 Wing Carbide	\$629

**V-Paneling Cutters:** These cutters are designed for high production use. Each cutter is split and can be shimmed for perfect fit. (4 1/8" Diameter)

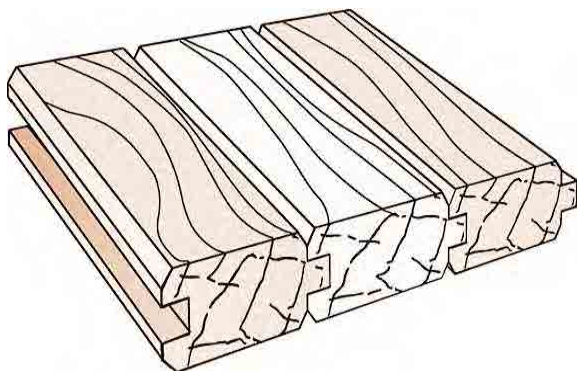

- Panels from 5/8" to 1 1/8" thick
- Designed for production
- Cutters are split for shimming to perfect fit after sharpening
- Cutters are split for various stock, 'V' and tongue widths

**This cutter set will make all sizes below - Example Wood Profiles:**

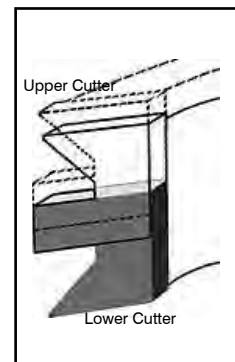
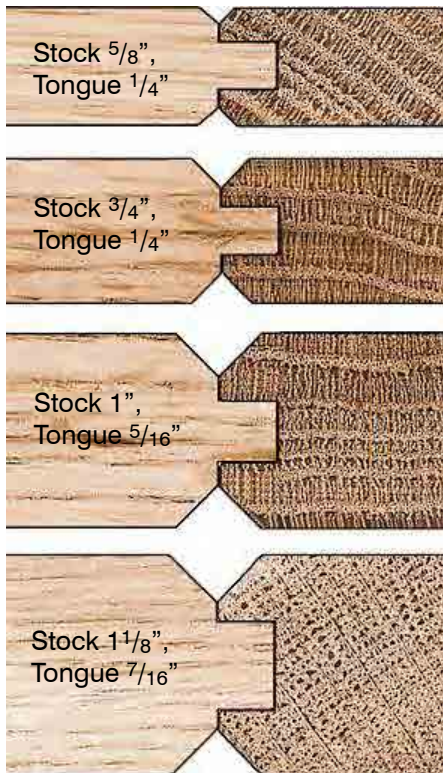

The overlapping cutter enables variation of stock, tongue and "V".

MADE IN GERMANY

Phone 1-913-831-1800

**CALL TOLL FREE 1-800-255-6214**

Fax 1-913-831-2974

CAT-SUP-CU-WSL - 126 -

WEAVER COMPANY - 1108 SOUTH 37TH STREET - KANSAS CITY, KS 66106 USA

Copyright © 2014 all Rights Reserved

**CONVEX HALF ROUND CUTTERS**

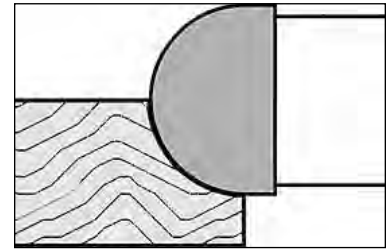
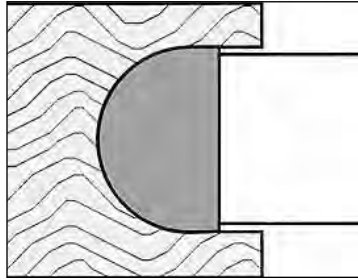
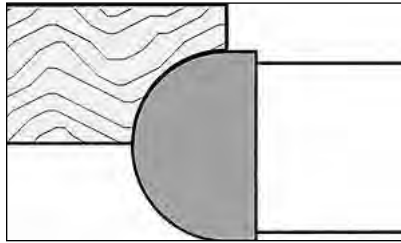

CONVEX HALF ROUND CUTTER EXAMPLES

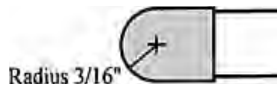

**3/16" Radius Convex Half Round Edge Cutters**

Item#	Wings	O.D.	Type	Price
<b>C8416V</b>	3	3 1/8"	Carbide	<b>\$109</b>
<b>C8418V</b>	2	3 1/8"	High Speed Steel	<b>\$69</b>

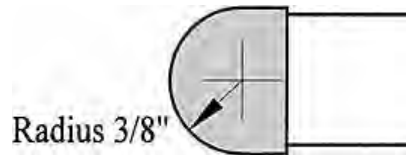

**3/8" Radius Convex Half Round Edge Cutters**

Item#	Wings	O.D.	Type	Price
<b>C8436V</b>	3	3-1/2"	Carbide	<b>\$159</b>

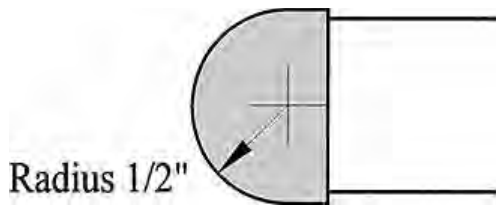

**1/2" Radius Convex Half Round Edge Cutters**

Item#	Wings	O.D.	Type	Price
<b>C8446V</b>	3	3-3/4"	Carbide	<b>\$199</b>
<b>C8448V</b>	2	3-3/4"	High Speed Steel	<b>\$129</b>

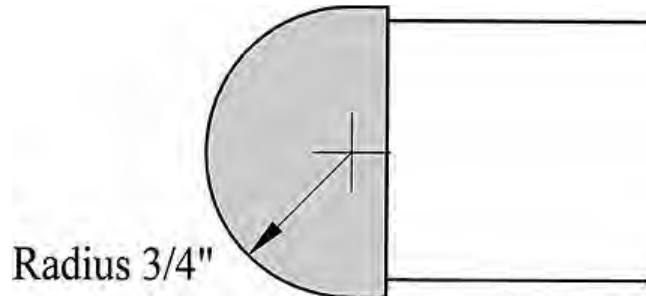

**3/4" Radius Convex Half Round Edge Cutters**

Item#	Wings	O.D.	Type	Price
<b>C8456V</b>	3	4-1/4"	Carbide	<b>\$289</b>
<b>C8458V</b>	2	4-1/4"	High Speed Steel	<b>\$179</b>

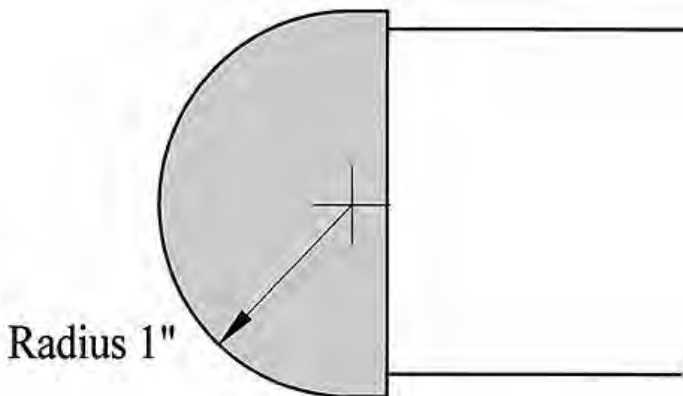

**1" Radius Convex Half Round Edge Cutters**

Item#	Wings	O.D.	Type	Price
<b>C8468V</b>	2	4-3/4"	High Speed Steel	<b>\$189</b>

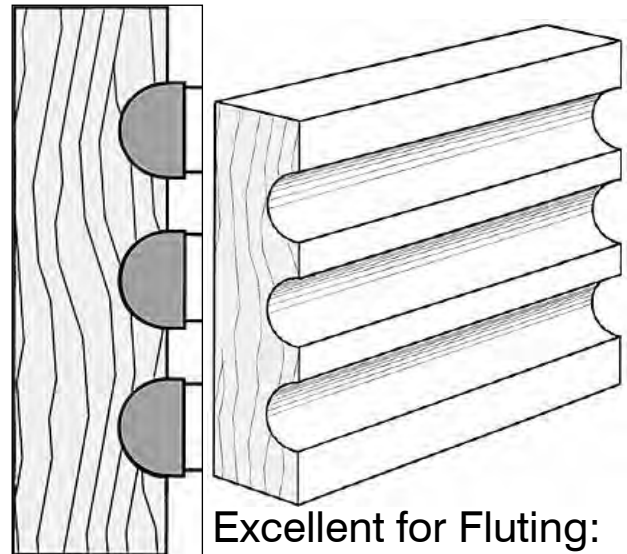

**Excellent for Fluting:**

MADE IN GERMANY

www.weaver-company.com



**Shaper Cutters**  
While Supplies Last!

# CONCAVE EDGE SHAPER CUTTERS

1<sup>1</sup>/<sub>4</sub> Bore

**WEAVER**  
**Stahl**

## CONCAVE HALF ROUND CUTTERS

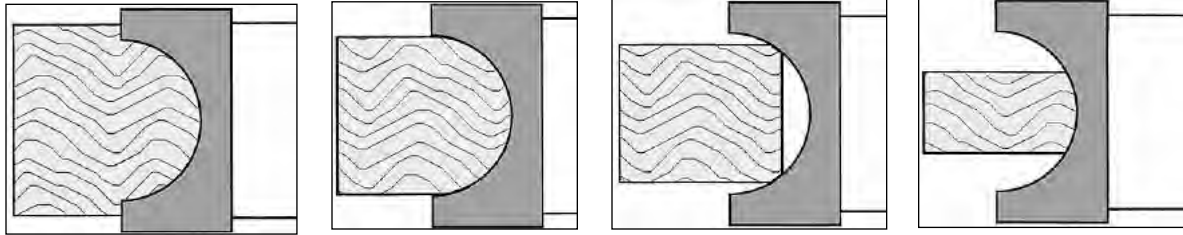

CONCAVE HALF ROUND CUTTER EXAMPLES

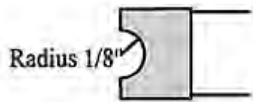

**1/8" Radius Concave Half Round Edge Cutters**

Item#	Wings	O.D.	Type	Price
C8508V	2	3"	High Speed Steel	\$89

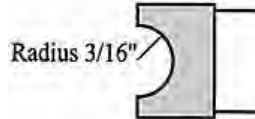

**3/16" Radius Concave Half Round Edge Cutters**

Item#	Wings	O.D.	Type	Price
C8516V	3	3 <sup>1</sup> / <sub>8</sub> "	Carbide	\$159
C8518V	2	3-1/8"	High Speed Steel	\$99

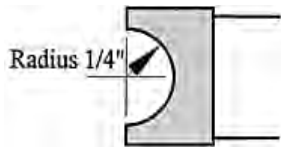

**1/4" Radius Concave Half Round Edge Cutters**

Item#	Wings	O.D.	Type	Price
C8528V	2	3-3/4"	High Speed Steel	\$129

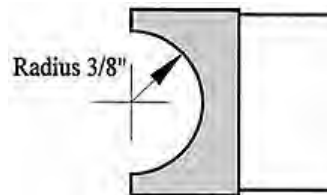

**3/8" Radius Concave Half Round Edge Cutters**

Item#	Wings	O.D.	Type	Price
C8539V	2	3-1/2"	Carbide	\$179

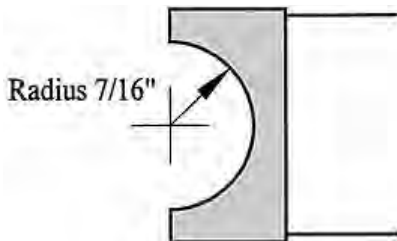

**7/16" Radius Concave Half Round Edge Cutters**

Item#	Wings	O.D.	Type	Price
C8546V	3	3-5/8"	Carbide	\$229
C8548V	2	3-5/8"	High Speed Steel	\$149

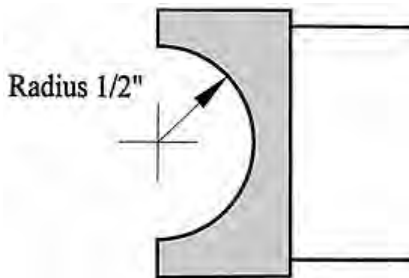

**1/2" Radius Concave Half Round Edge Cutters**

Item#	Wings	O.D.	Type	Price
C8559V	2	3-3/4"	Carbide	\$219

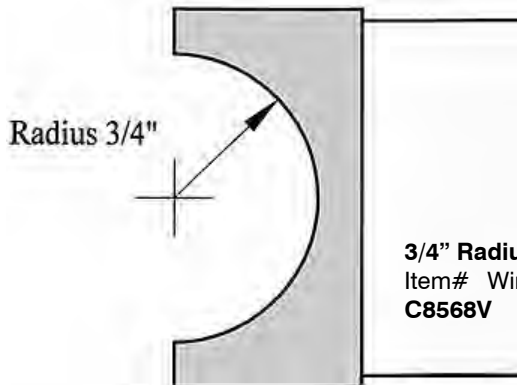

**3/4" Radius Concave Half Round Edge Cutters**

Item#	Wings	O.D.	Type	Price
C8568V	2	4-1/4"	High Speed Steel	\$209

MADE IN GERMANY

Phone 1-913-831-1800

**CALL TOLL FREE 1-800-255-6214**

Fax 1-913-831-2974

CAT-SUP-CU-WSL - 128 -

WEAVER COMPANY - 1108 SOUTH 37TH STREET - KANSAS CITY, KS 66106 USA

Copyright © 2014 all Rights Reserved

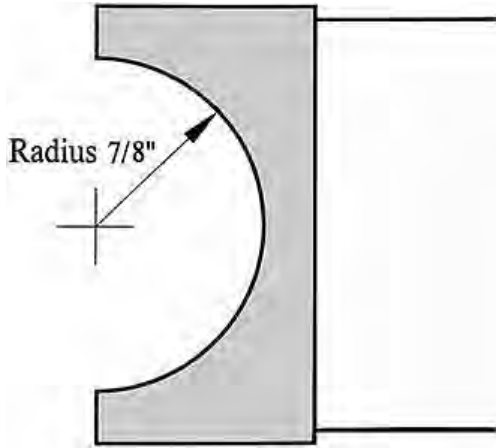

**7/8" Radius Concave Half Round Edge Cutters**

Item#	Wings	O.D.	Type	Price
<b>C8576V</b>	3	4-1/2"	Carbide	<b>\$249</b>
<b>C8578V</b>	3	4-1/2"	High Speed Steel	<b>\$169</b>

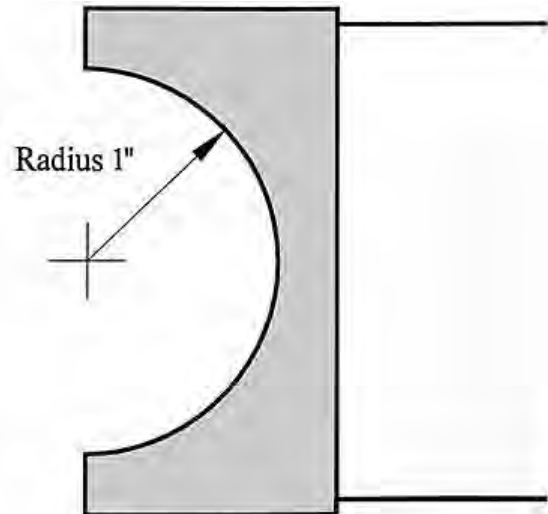

**1" Radius Concave Half Round Edge Cutters**

Item#	Wings	O.D.	Type	Price
<b>C8596V</b>	3	4-3/4"	Carbide	<b>\$289</b>
<b>C8598V</b>	3	4-3/4"	High Speed Steel	<b>\$189</b>

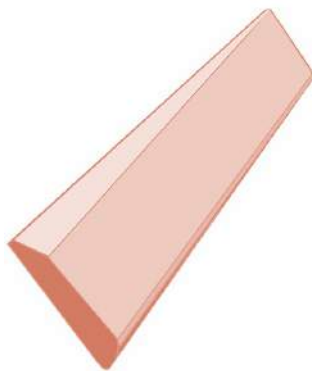

**Multiform Deluxe Slip Stone**

Specially shaped stone for sharpening gouges, carving tools, garden shears, and other tools with curved cutting edges.

**Multiform Deluxe Slip Stone**

Item#	Price
<b>WS1000</b> 110x50x10mm, 1000 Grit	<b>\$10ea</b>

Made in Japan.

Soak the stone in water for two minutes before using. Sprinkle water on stone as needed to keep it sufficiently wet; water acts as a lubricant.

**MADE IN GERMANY**

[www.weaver-company.com](http://www.weaver-company.com)

**Shaper Cutters**  
*While Supplies Last!*

**CONVEX EDGE SHAPER CUTTERS**  
 1 1/4 Bore



**CONVEX QUARTER ROUND CUTTERS**

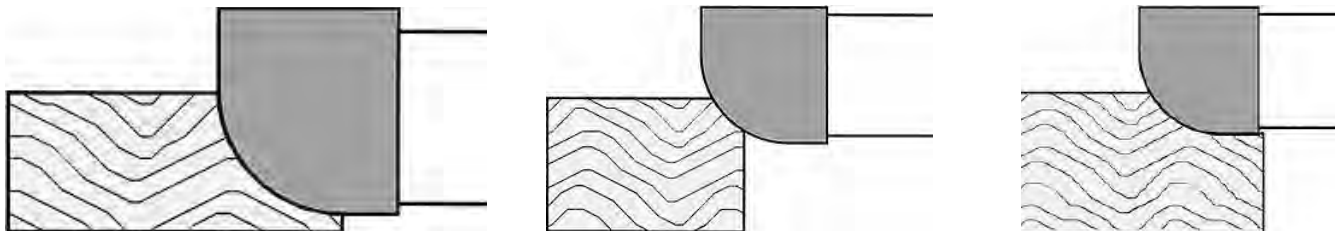

CONVEX QUARTER ROUND CUTTER EXAMPLES

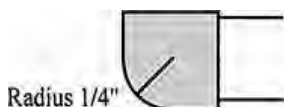

Radius 1/4"

**1/4" Radius Convex Quarter Round Edge Cutters**

Item#	Wings	O.D.	Type	Price
<b>C8608V</b>	2	3-1/4"	High Speed Steel	<b>\$69</b>

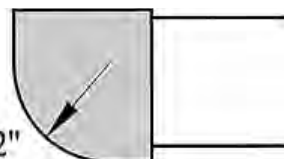

Radius 1/2"

**1/2" Radius Convex Quarter Round Edge Cutters**

Item#	Wings	O.D.	Type	Price
<b>C8618V</b>	2	3-3/4"	High Speed Steel	<b>\$119</b>
<b>C8619V</b>	2	3-3/4"	Carbide	<b>\$159</b>

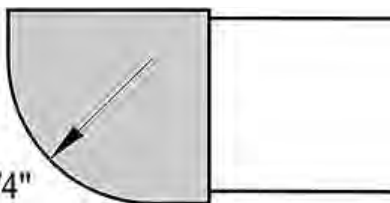

Radius 3/4"

**3/4" Radius Convex Quarter Round Cutters**

Item#	Wings	O.D.	Type	Price
<b>C8629V</b>	2	4-1/4"	Carbide	<b>\$199</b>

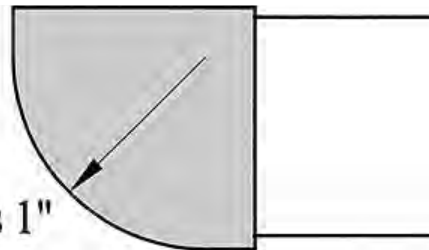

Radius 1"

**1" Radius Convex Quarter Round Edge Cutters**

Item#	Wings	O.D.	Type	Price
<b>C8638V</b>	2	4-3/4"	High Speed Steel	<b>\$159</b>

MADE IN GERMANY

Phone 1-913-831-1800

**CALL TOLL FREE 1-800-255-6214**

Fax 1-913-831-2974

CAT-SUP-CU-WSL - 130 -

WEAVER COMPANY - 1108 SOUTH 37TH STREET - KANSAS CITY, KS 66106 USA

www.weaver-company.com  
 Copyright © 2014 all Rights Reserved

**CONCAVE QUARTER ROUND CUTTERS**

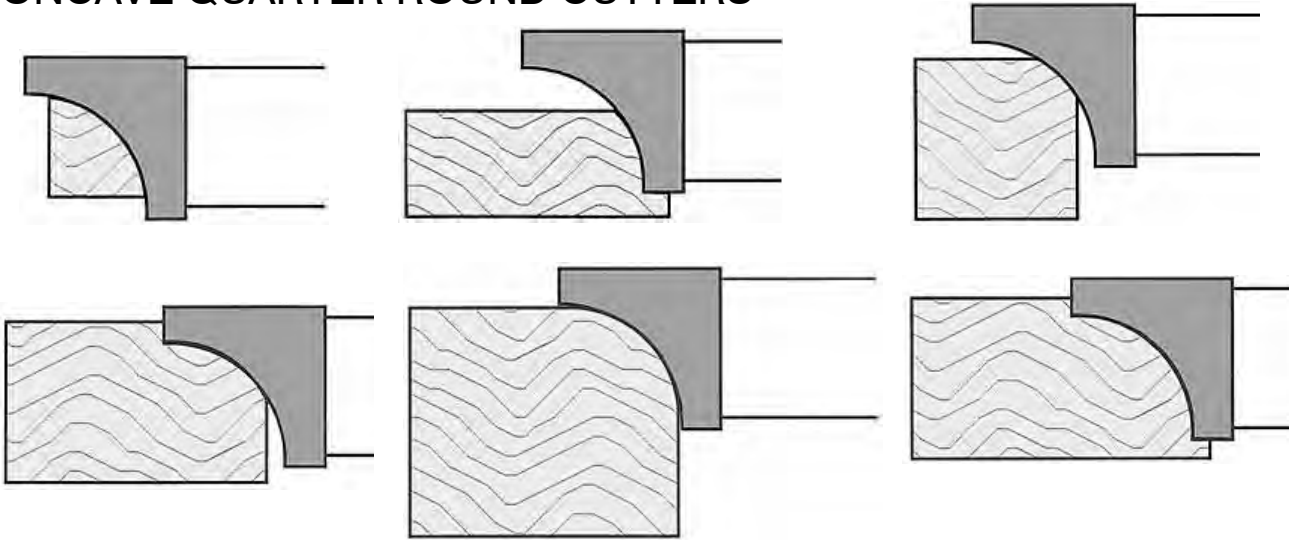

CONCAVE QUARTER ROUND CUTTER EXAMPLES

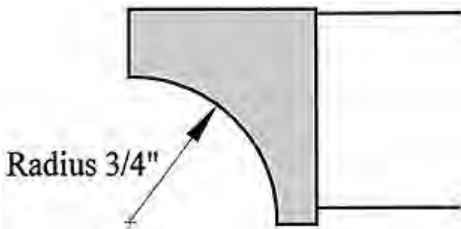

**3/4" Radius Concave Quarter Round Cutters**

Item#	Wings	O.D.	Type	Price
<b>C8668V</b>	2	4-1/4"	HSS	<b>\$129</b>
<b>C8669V</b>	2	4-1/4"	Carbide	<b>\$179</b>

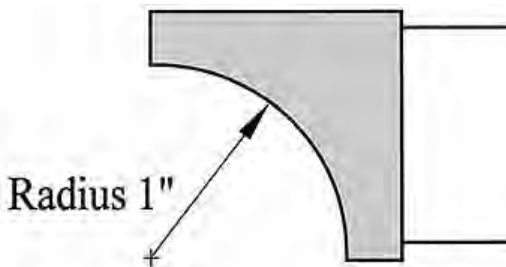

**1" Radius Concave Quarter Round Cutters**

Item#	Wings	O.D.	Type	Price
<b>C8676V</b>	3	4-3/4"	Carbide	<b>\$249</b>

MADE IN GERMANY

[www.weaver-company.com](http://www.weaver-company.com)

Phone 1-913-831-1800

**CALL TOLL FREE 1-800-255-6214**

Fax 1-913-831-2974

Copyright © 2014 all Rights Reserved

WEAVER COMPANY - 1108 SOUTH 37TH STREET - KANSAS CITY, KS 66106 USA

CAT-SUP-CU-WSL - 131 -

**House Door Set** ( $9/16"$  Tongue Length)

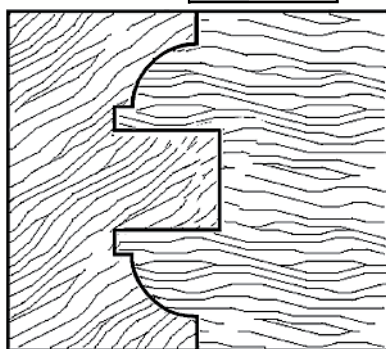
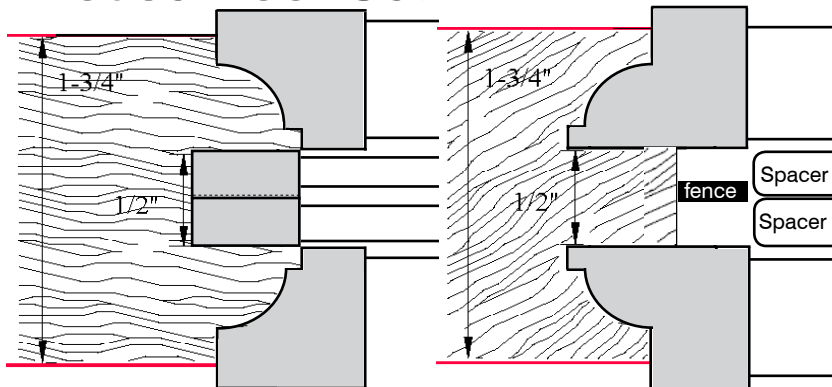

1 $3/4$ " Exterior Profile using 2 spacers & the  $9/32$ " &  $1/4$ " groovers.

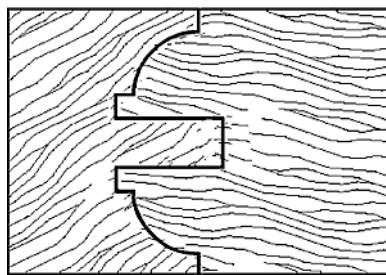

1 $3/8$ " Interior Profile, using one less spacer & the  $1/4$ " groover.

**Cabinet Door Set**

Cabinet Door Sets for  $3/4"$  to  $7/8"$  Thickness  
 $31/8"$  O.D. ( $1/2"$  Tongue Length)

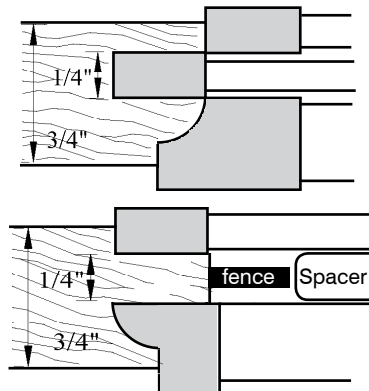

Cabinet Door Sets for  $3/4"$  to  $7/8"$  Thickness  
 $31/8"$  O.D.

Item#	Wings	Bore	Type	Price
C9015F1	2	$3/4"$	Carbide	<b>\$279</b>

(Price includes both tenon & stile cutters)

**1 $3/8$ " , 1 $3/4$ " House Door Set**

Item#	Wings	Bore	O.D.	Type	Price
C9215R2	2	$3/4"$	$31/8"$	Carbide	<b>\$369</b>

(Price includes both tenon & stile cutters)

**Optional Cutter for Glass Doors**

Item#	Wings	Height	Bore	O.D.	Type	Price
C9225V	2	$1/2"$	$3/4"$	$31/8"$	Carbide	<b>\$59</b>

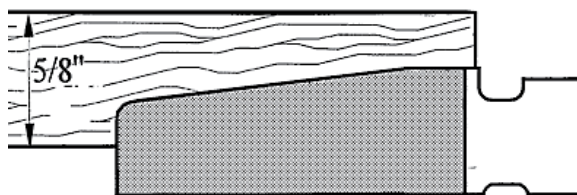

Item#	Wings	Type	Price
C7097D1	2	HSS	<b>\$129</b>

"Not Recessed for Bearing"

(This Raised Panel Cutter is 6" Diameter,  $3/4"$  Bore)

**Raised Panel Cutters**



Item#	Wings	Bore	O.D.	Reveal	Type	Price
C7085D3	2	$3/4"$	$4 3/4"$	$1 1/2"$	Carbide	<b>\$108</b>

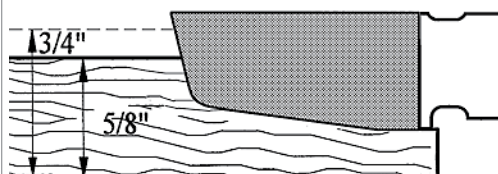

MADE IN GERMANY

www.weaver-company.com

**House Door Set (1/2" Tongue Length)**

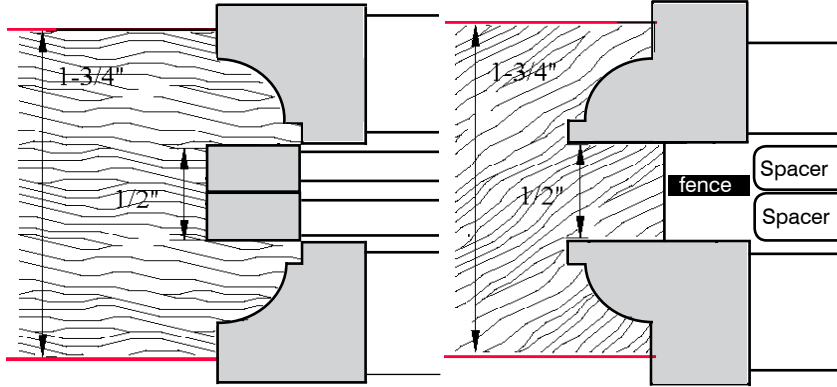

**1<sup>3</sup>/<sub>8</sub>", 1<sup>3</sup>/<sub>4</sub>" House Door Set**

Item# Wings Bore O.D. Type Price

**C9218R2** 2 1<sup>1</sup>/<sub>4</sub>" 4" HSS **\$489**  
 (Price includes both tenon & stile cutters)

**Optional Cutter for Glass Doors**

Item# Wings Height Bore O.D. Type Price

**C9238V** 2 3/4" 1 1/4" 4" HSS **\$79**

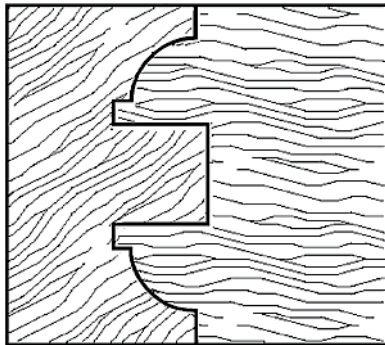

1<sup>3</sup>/<sub>4</sub>" Exterior Profile using 2 spacers & the 9/32" & 1/4" groovers.

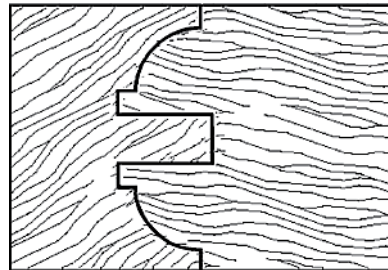

1<sup>3</sup>/<sub>8</sub>" Interior Profile, using one spacer & the 1/4" groover.



**Shaker House Door Set**

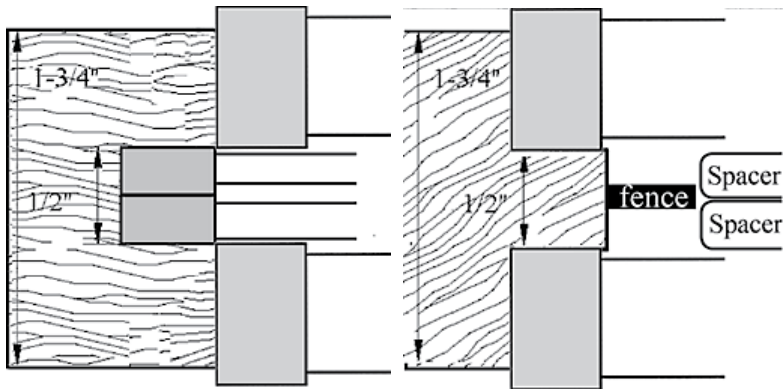

**1<sup>3</sup>/<sub>8</sub>", 1<sup>3</sup>/<sub>4</sub>" Shaker House Door Set**

Item# Wings Bore O.D. Type Price

**C9298R2** 2 1<sup>1</sup>/<sub>4</sub>" 4" HSS **\$389**  
 (Price includes both tenon & stile cutters)

**Optional Cutter for Glass Doors**

Item# Wings Height Bore O.D. Type Price

**C9238V** 2 3/4" 1 1/4" 4" HSS **\$79**

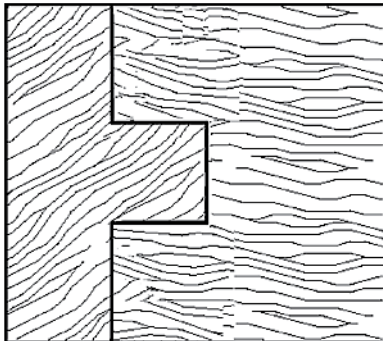

1<sup>3</sup>/<sub>4</sub>" Exterior using 2 spacers & the 9/32" & 1/4" groovers.

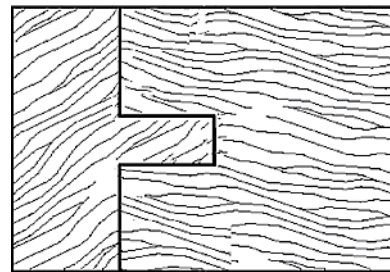

1<sup>3</sup>/<sub>8</sub>" Interior using one spacer & the 1/4" groover.

MADE IN GERMANY

www.weaver-company.com

# Crown Molding Cutters:



Item No.	Wings	Height	O.D.	Type	Price
<b>C9758V</b>	2	2 1/8"	3 5/32"	High Speed Steel	<b>\$299</b>

Item No.	Wings	Height	O.D.	Type	Price
<b>C9768V</b>	2	3"	3 1/2"	High Speed Steel	<b>\$369</b>

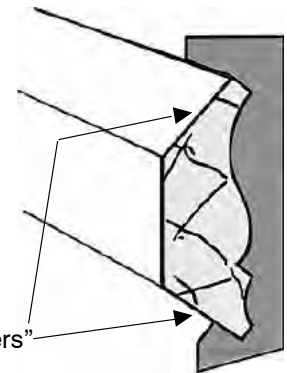

**USA STOCKED FOR FAST DELIVERY**

## Room Chair Rail Molding Cutters

This cutter from Weaver's produces excellent wall molding for chair railings

Item#	Wings	O.D.	Height	Type	Price
<b>C9788V</b>	2	3 3/4"	2 3/4"	High Speed Steel	<b>\$399</b>

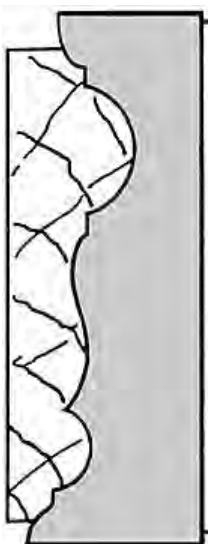

MADE IN GERMANY

## HEAD MOLDING CUTTERS

This cutter produces excellent head mold for the joint between upper cabinets and soffits as ceiling trim.

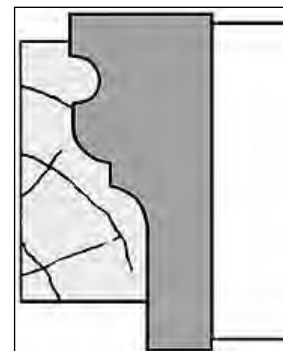

### Cabinet Head Molding Cutters

Item#	Wings	O.D.	Type	Price
<b>C9736V</b>	3	3 1/2"	Carbide	<b>\$359</b>
<b>C9738V</b>	2	3 1/2"	HSS	<b>\$239</b>
<b>C9739V</b>	2	3 1/2"	Carbide	<b>\$329</b>

**MOLDING CUTTERS**

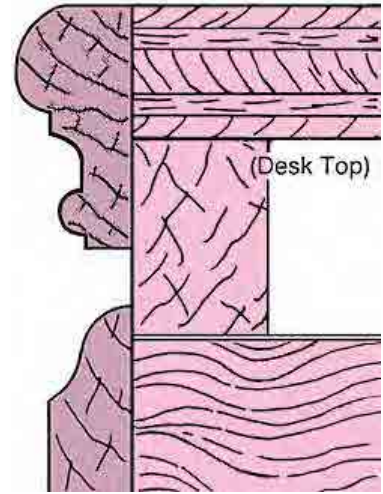
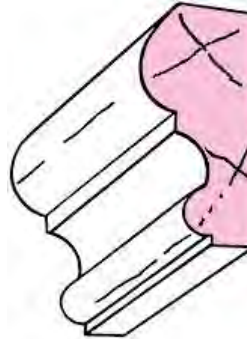
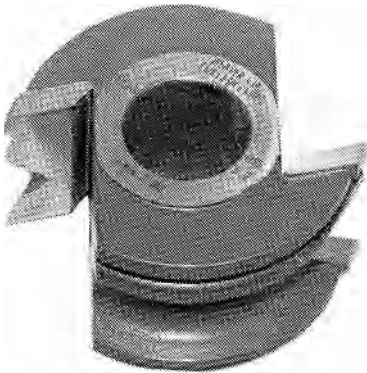

This cutter produces excellent moldings for desk tops, wall moldings, slab cabinet doors and oven cabinet caps.

**Oven and Desk Molding Cutters**

Item#	Wings	O.D.	Type	Price
<b>C9748V</b>	2	3-5/8"	High Speed Steel	<b>\$239</b>
<b>C9749V</b>	2	3-5/8"	Carbide	<b>\$329</b>

MADE IN GERMANY

[www.weaver-company.com](http://www.weaver-company.com)

Phone 1-913-831-1800

**CALL TOLL FREE 1-800-255-6214**

**Fax 1-913-831-2974**

Copyright © 2014 all Rights Reserved

WEAVER COMPANY - 1108 SOUTH 37TH STREET - KANSAS CITY, KS 66106 USA

CAT-SUP-CU-WSL - 135 -